

dinamica ballet

Specialists in ballet barres
and dance mirrors



PORTABLE
BALLET
BARRES



FLOOR
MOUNTED
SUPPORTS



WALL
MOUNTED
SUPPORTS



PORTABLE
AND FIXED
MIRRORS



BALLET
MATS





PORTABLE BALLET BARRES

Our portable ballet barres range from the **ROYALE, MAURICE, GISELLE, PINA, ISA,** and **AVANT** models; which are designed for professional ballet, dance and fitness workouts, to the **PRIMA** and the **JULIETTE**, portable ballet barres specifically designed for home use.

We have aimed to create barres that are easy to move, but without compromising strength and stability. To fully maximize the available space and the number of users on each, all our portable barres can be used from both sides of the wooden beam.

You will find these stylish and sturdy ballet barres are built to the highest level of quality. Our equipment stands up to the rigours of everyday use and will last many years to come. Thanks to these characteristics, dinamica ballet equipment has gained a leading national and international market position.



ROYALE



MAURICE



GISELLE



PINA



ISA



AVANT



JULIETTE



PRIMA

ROYALE



ROYALE is one of our most versatile ballet barres and suitable for all types of dancers of different stature. It is a premium, height-adjustable, freestanding, portable ballet barre that has two wooden beams with 10 pre-set heights and cast iron bases to give maximum stability.

The bases are equipped with small wheels on both sides of the barre to allow a single user to move the ROYALE in whichever direction they desire. Once in position, a clever design ensures the wheels are off the floor so that the ballet barre's stability is left uncompromised.

Product features

- 2 Southern yellow pine bars included (smoothed and unvarnished).
- 10 adjustable heights.
- Steel uprights in silver with cast iron bases.
- Rubber wheels on both sides of the bases.

Height of bars, position 1	U.b.: 96.5 cm L.b.: 73.5 cm
Height of bars, position 10	U.b.: 123 cm L.b.: 100.5 cm
Distance between bars	19 cm
Diameter of uprights	50 mm Ø
Diameter of bars	40 mm Ø
Base dimensions	41 x 25 x 7 cm
Length of wooden bars	2 m or 3 m
Total weight	76 kg with 2 metre bars 77.5 kg with 3 metre bars

U.b.: Upper bar | L.b.: Lower bar

MAURICE



MAURICE is a premium ballet barre from dinamica ballet.

It has two wooden beams and cast iron bases to give maximum stability.

The bases are equipped with small wheels on both sides of the barre to allow a single user to move the MAURICE in whichever direction they desire. Once in position, a clever design ensures the wheels are off the floor so that the ballet barre's stability is left uncompromised.

Product features

- 2 Southern yellow pine bars included (smoothed and unvarnished).
- Steel uprights in silver with cast iron bases.
- Rubber wheels on both sides of the bases.

Height of bars	U.b.: 105.5 cm L.b.: 83 cm
Distance between bars	19 cm
Diameter of uprights	50 mm Ø
Diameter of bars	40 mm Ø
Base dimensions	41 x 25 x 7 cm
Length of wooden bars	2 m or 3 m
Total weight	74 with 2 metre bars 75.5 kg with 3 metre bars

U.b.: Upper bar | L.b.: Lower bar



GISELLE

GISELLE is one of our most versatile ballet barres and suitable for all types of dancers of different stature. Similar to the ROYALE, the GISELLE is a height-adjustable, freestanding, portable ballet barre but with steel bases instead of cast iron. It has two wooden beams with 10 pre-set heights.

The steel bases give the advantage of making the GISELLE lighter and to maintain the same stability and mobility, we have made the bases flatter and wider.

The bases come with the option of small wheels.

Product features

- 2 Southern yellow pine bars included (smoothed and unvarnished).
- 10 adjustable heights.
- Steel uprights and bases in silver.
- Bases with rubber wheels (optional).



Position 1, without wheels:	U.b.: 93.5 cm L.b.: 70.5 cm
Position 10, without wheels:	U.b.: 120.5 cm L.b.: 97.5 cm
Position 1, with wheels:	U.b.: 94.5 cm L.b.: 71.5 cm
Position 10, with wheels:	U.b.: 121 cm L.b.: 98.5 cm
Distance between bars	19 cm
Diameter of upright	50 mm Ø
Diameter of bars	40 mm Ø
Base dimensions	Without wheels: 39.5 x 32 x 1 cm With wheels: 39.5 x 32 x 2 cm
Length of wooden bars	1.5 m, 2 m or 3 m
Total weight, without wheels	34 kg with 1.5 metre bars 35 kg with 2 metre bars 36 kg with 3 metre bars
Total weight, with wheels	53 kg with 1.5 metre bars 54 kg with 2 metre bars 55 kg with 3 metre bars

U.b.: Upper bar | L.b.: Lower bar

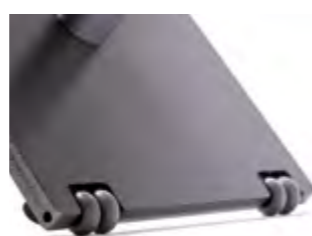

PINA

PINA has two wooden beams and is similar to MAURICE but with steel bases instead of cast iron.

Steel bases give the advantage of making the PINA lighter and to maintain the same stability and mobility, we have made the bases flatter and wider.

The bases come with the option of small wheels.

Product features

- 2 Southern yellow pine bars included (smoothed and unvarnished).
- Steel uprights and bases in silver.
- Bases with rubber wheels (optional).

Height of bars

Without wheels	U.b.: 101 cm L.b.: 79 cm
With wheels	U.b.: 102 cm L.b.: 80 cm
Distance between bars	19 cm
Diameter of upright	50 mm Ø
Diameter of bars	40 mm Ø
Base dimensions	Without wheels: 39.5 x 32 x 1 cm With wheels: 39.5 x 32 x 2 cm
Length of wooden bars	1.5 m, 2 m or 3 m
Total weight, without wheels	31.5 kg with 1.5 metre bars 32.5 kg with 2 metre bars 34 kg with 3 metre bars
Total weight, with wheels	50.5 kg with 1.5 metre bars 51 kg with 2 metre bars 52.5 kg with 3 metre bars

U.b.: Upper bar | L.b.: Lower bar



ISA



ISA is one of our most versatile ballet barres with a choice of 14 selectable heights making it suitable for all types of dancers of different stature.

The ballet barre has a single wooden beam that we offer in three different standard lengths.

ISA comes with the choice of wheels or without and both options do not compromise the portability and stability of the barre.

Product features

- 1 Southern yellow pine bar included (smoothed and unvarnished).
- 14 adjustable heights.
- Steel uprights and bases in silver.
- Bases with rubber wheels (optional).

Height of bar, without wheels	Position 1: 79.5 cm Position 14: 118.5 cm
Height of bar, with wheels	Position 1: 80.5 cm Position 14: 119.5 cm
Diameter of uprights	50 mm Ø
Diameter of bar	40 mm Ø
Base dimensions	Without wheels: 39.5 x 32 x 1 cm With wheels: 39.5 x 32 x 2 cm
Length of wooden bars	1 m, 1.5 m, 2 m or 3 m
Total weight, without wheels	30.5 kg with 1 metre bar 31 kg with 1.5 metre bar 31.5 kg with 2 metre bar 32 kg with 3 metre bar
Total weight, with wheels	50 kg with 1.5 metre bar 50.5 kg with 2 metre bar 51 kg with 3 metre bar



AVANT

The AVANT ballet barre is similar to our PINA model but with a single wooden beam. Its design offers stability, strength and mobility.

The ballet barre comes with the choice of wheels or without and both options do not compromise the portability and stability of the AVANT.



Product features

- 1 Southern yellow pine bar included (smoothed and unvarnished).
- Steel uprights and bases in silver.
- Bases with rubber wheels (optional).

Height of the bar	Without wheels: 103 cm With wheels: 104 cm
Diameter of uprights	50 mm Ø
Diameter of bar	40 mm Ø
Base dimensions	Without wheels: 39.5 x 32 x 1 cm With wheels: 39.5 x 32 x 2 cm
Length of wooden bar	1 m, 1.5 m, 2 m or 3 m
Total weight, without wheels	27.5 kg with 1 metre bar 28 kg with 1.5 metre bar 28.5 kg with 2 metre bar 29 kg with 3 metre bar
Total weight, with wheels	47 kg with 1.5 metre bar 47.5 kg with 2 metre bar 48 kg with 3 metre bar



JULIETTE



The Juliette is a height-adjustable ballet barre designed to be used at home, that can be set to 12 different heights making it suitable for all types of dancers of different stature.

The design of this ballet barre combines a lightweight frame with strength and stability.

Product features

- 1 Southern yellow pine bar included (smoothed and unvarnished).
- 12 adjustable heights.
- Steel uprights and bases in silver.

Height of the bar position 1	77 cm
Height of the bar position 12	110 cm
Diameter of uprights	40 mm Ø
Diameter of bar	40 mm Ø
Base dimensions	39.5 x 32 x 0.6 cm
Length of wooden bar	1 m, 1.5 m or 2 m
Total weight	18 kg with 1 metre bar 18.5 kg with 1.5 metre bar 19 kg with 2 metre bar



PRIMA

Designed for personal use, PRIMA is suitable for adults and children alike. It is a popular piece of equipment for dancers practising at home and also for barre workouts.

Our PRIMA ballet barre combines a lightweight frame with strength and stability.



Product features

- 1 Southern yellow pine bar included (smoothed and unvarnished).
- Steel uprights and bases in silver.

Height of the bar	96 cm
Diameter of uprights	40 mm Ø
Diameter of bar	40 mm Ø
Base dimensions	39.5 x 32 x 0.6 cm
Length of wooden bar	1 m, 1.5 m or 2 m
Total weight	15.5 kg with 1 metre bar 16 kg with 1.5 metre bar 16.5 kg with 2 metre bar

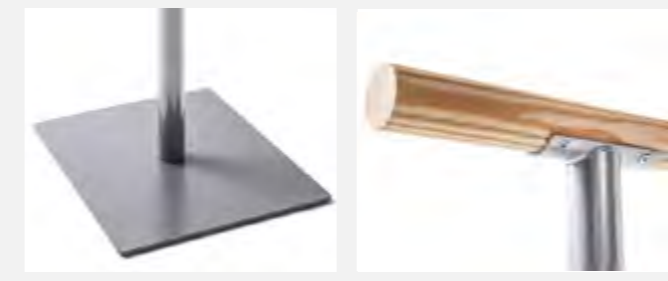

DOUBLE PORTABLE BALLET BARRES WITH 3 SUPPORTS

Barres 4 or 5 meters long with 3 silver-finished supports

dinamica ballet

DOUBLE BALLET BARRES
PORTABLE



ROYALE

Set of 3 ROYALE supports
+ 4 wooden beams of 2 or 2.5 m

Product features

- Set of 3 adjustable supports in 10 different heights.
- Cast iron bases with 4 rubber wheels each.

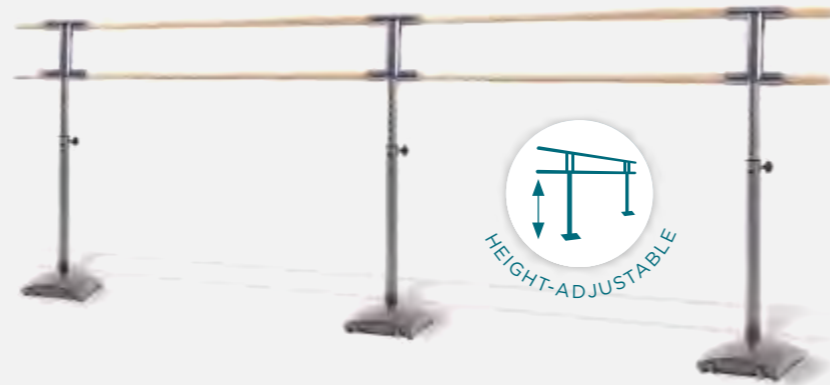

MAURICE

Set of 3 MAURICE supports
+ 4 wooden beams of 2 or 2.5 m

Product features

- Set of 3 supports for wooden beams at 2 heights.
- Cast iron bases with 4 rubber wheels each.



GISELLE

Set of 3 GISELLE supports
+ 4 wooden beams of 2 or 2.5 m

Product features

- Set of 3 adjustable supports in 10 different heights.
- Silver steel base with or without rubber wheels (optional).

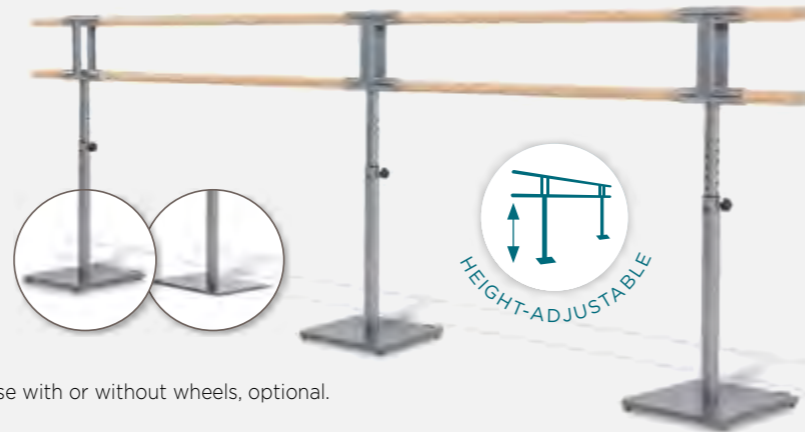

PINA

Set of 3 PINA supports
+ 4 wooden beams of 2 or 2.5 m

Product features

- Set of 3 supports for wooden beams at 2 heights.
- Silver steel base with or without rubber wheels (optional).

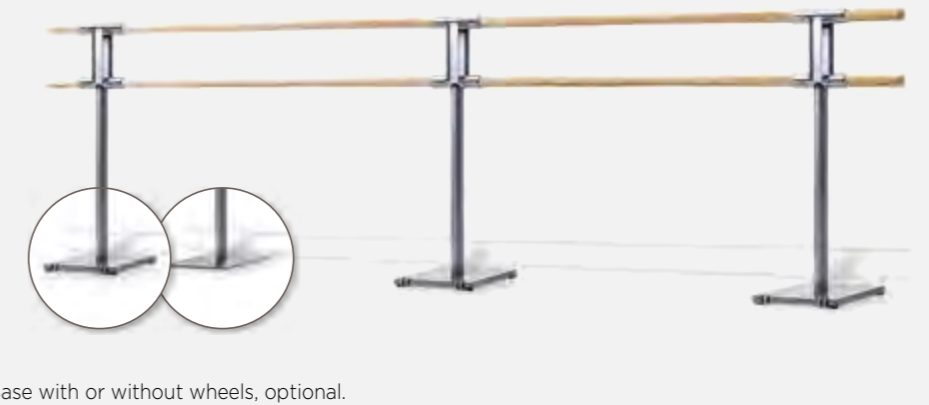

SINGLE PORTABLE BALLET BARRES WITH 3 SUPPORTS

Barres 4 or 5 meters long with 3 silver-finished supports.

SINGLE BALLET BARRES WITH 3 SUPPORTS
PORTABLE



ISA

Set of 3 ISA supports
+ 2 wooden beams of 2 or 2.5 m

Product features

- Set of 3 adjustable supports in 14 different heights.
- Silver steel base with or without rubber wheels (optional).



AVANT

Set of 3 AVANT supports
+ 2 wooden beams of 2 or 2.5 m

Product features

- Set of 3 adjustable supports for single wooden beams.
- Silver steel base with or without rubber wheels (optional).





FLOOR MOUNTED SUPPORTS

Our floor mounted supports are single column steel uprights that are firmly fixed to the ground with four heavy duty bolts.

They are suitable for all types of floors, with robust bases and a closed cradle design to ensure they can handle a multitude of uses from dance to fitness.

Our floor mounted uprights can all be installed in conjunction with our wall supports.



GISELLE-FIX



PINA-FIX



ISA-FIX



AVANT-FIX

GISELLE-FIX

Height adjustable to ten different positions and designed to hold a double row of wooden beams.



Product features

- Floor mounted ballet bar support. 10 adjustable heights.
- Steel upright and base in silver.

Height of bars - Position 1	91.5 and 68.5 cm
Height of bars - Posición 10	118.5 and 95.5 cm
Diameter of upright	50 mm Ø
For wooden bars with a diameter	40 mm Ø
Base dimensions	18 x 10 x 0.6 cm
Weight per support	6.5 kg
Recommended max. distance between supports	1.5 m to 2 m

PINA-FIX

Designed to hold a double row of wooden beams.



Product features

- Floor mounted double ballet bar support.
- Steel upright and base in silver or black..

Height of bars	77.5 and 101 cm
Distance between bars	19 cm
Diameter of upright	50 mm Ø
For wooden bars with a diameter	40 mm Ø
Base dimensions	18 x 10 x 0.6 cm
Weight per support	5.5 kg
Recommended max. distance between supports	1.5 m to 2 m

ISA-FIX

Height adjustable to fourteen different positions and designed to hold a single row of wooden beams.



Product features

- Floor mounted ballet bar support. 14 adjustable heights.
- Steel upright and base in silver.

Height position 1	79.5 cm
Height position 14	118 cm
Diameter of upright	50 mm Ø
For wooden bars with a diameter	40 mm Ø
Base dimensions	18 x 10 x 0.6 cm
Weight per support	5.5 kg
Recommended max. distance between supports	1.5 m to 2 m

AVANT-FIX

Designed to hold a single row of wooden beams.



Product features

- Floor mounted ballet bar support.
- Steel upright and base in silver or black.

Height	103 cm
Diameter of upright	50 mm Ø
For wooden bars with a diameter	40 mm Ø
Base dimensions	18 x 10 x 0.6 cm
Weight per support	4.5 kg
Recommended max. distance between supports	1.5 m to 2 m



WALL MOUNTED SUPPORTS

Firmly attached to your wall, our steel brackets can support one or two rows of wooden beams.

WOODEN BARS

Fine Southern yellow pine wood (smoothed and unvarnished).

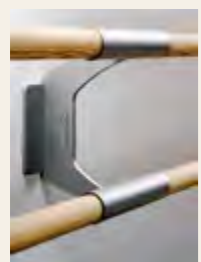

ARABESQUE DOUBLE



ARABESQUE SINGLE



TWIST



WOODEN BARS

ARABESQUE DOUBLE

Designed to hold a double row of wooden beams.

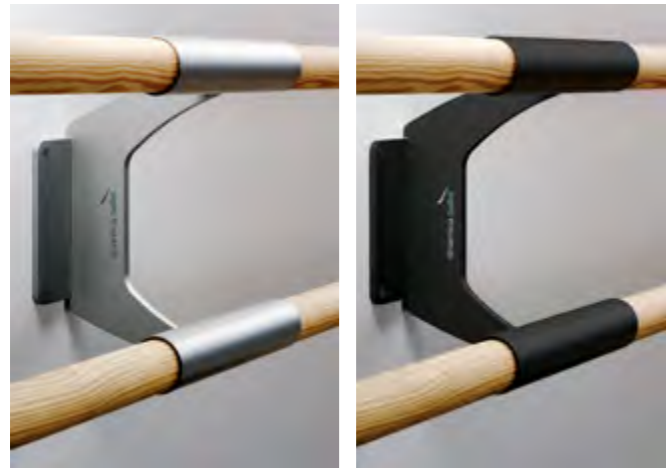

ARABESQUE SINGLE

Designed to hold a single row of wooden beams.



Our steel brackets have a cylindrical saddle to ensure that the bars won't tear free with pulling or pushing, making them suitable for a wide variety of uses.

These wall mounted brackets can be installed in conjunction with our floor supports.

Product features

- Steel wall brackets in silver or black.
- Suitable for bars with a diameter of 40 mm.

	ARABESQUE DOUBLE	ARABESQUE SINGLE
Distance between bars and wall	18 cm	18 cm
Distance between the bars (Arabesque Double)	19 cm	--
Weight	1.7 kg	1.15 kg
Recommended max. distance between supports	1.5 to 2 m	1.5 to 2 m

TWIST



TWIST bar-end wall support allows you to install a ballet barre across opposite facing walls. This versatility gives greater possibilities to fully utilize your space.

Compatible with all our fixed barres.

Product features

- Steel supports in silver or black.
- Designed for wooden beams with a diameter of 40 mm.

Weight	300 g
Recommended maximum distance between TWIST supports	1.5 m

WOODEN BARS



Wooden bars offer the feel that dancers worldwide enjoy. Our pine wood bars provide that slight "give" which a metal bar simply cannot offer.

They are strong and durable and delivered unvarnished to improve the grip for the user. The edges have been smoothly finished to avoid any unnecessary harm.

Our standard bars are available in a number of different lengths, but we can also create customised measures to suit your needs. They are also available in beech wood.

Product features

- Fine Southern yellow pine wood (smoothed and unvarnished).
- Beech wood bars are also available.

Standard length	1 / 1.5 / 2 / 3 m
Diameter	40 mm Ø
Weight	1 m 0.8 kg
	1.5 m 1.1 kg
	2 m 1.5 kg
	3 m 2.2 kg

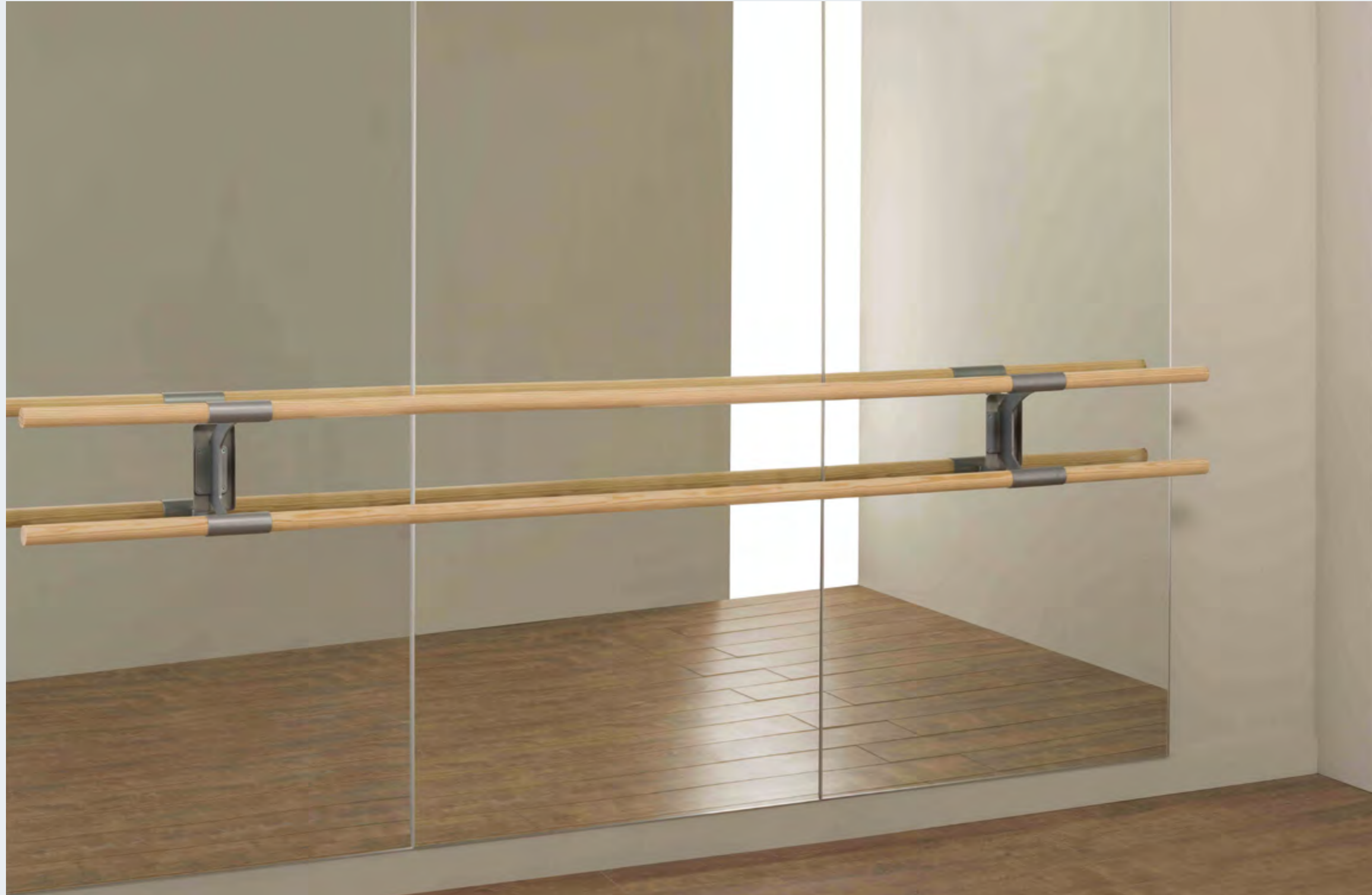
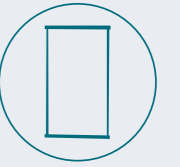

DANCE MIRRORS:

PORTABLE

FIXED

SCREEN PRINTED

INTEGRATABLE
WITH FIX
WALL MOUNTED
SUPPORTS



BILLY



FIGARO

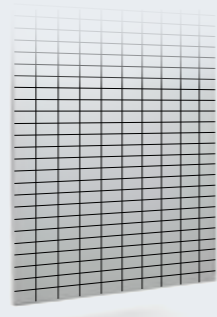

BORIS



AMADEUS

BILLY

Our mobile mirror BILLY is easy to move around and just as easy to lock into a fixed, stable position.

The innovative design of BILLY allows multiple mirrors to be connected together to form one large, single, continuous mirror surface.

Our mirrors are mounted vertically without any inclination to ensure a true image for the viewer and with our commitment to quality, you can be assured they are warp free.

Product features

- Safety glass.
- Vertical mirror with no inclination.
- Floor module with swivel, height-adjustable, wheels and brakes.
- User handles to avoid leaving fingerprints.
- Multiple BILLYs connect to form one continuous mirror.

Dimensions	190 x 100 x 53 cm
Mirror thickness	4 mm
Total weight	45 kg

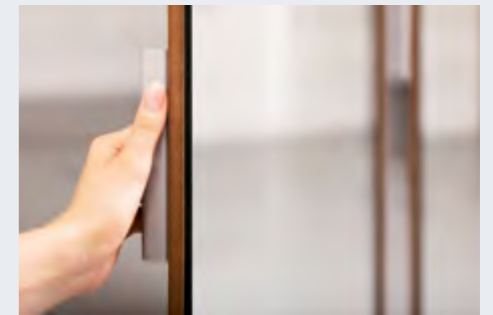
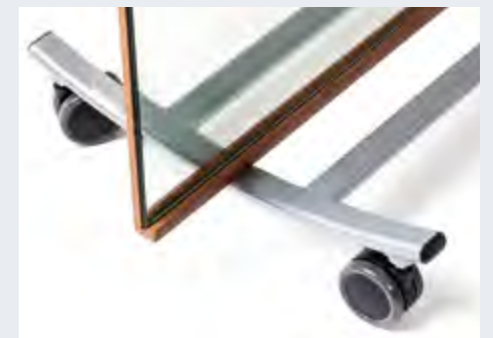

FIGARO

A mounted mirror hung flat against the wall and designed with safety in mind.

FIGARO does not require skilled tradesmen to install. It has an aluminium frame available in silver or black and can be mounted vertically or horizontally.

There is a security film applied in its construction to make the mirror safe in case of accidental damage. The film serves to prevent broken glass shards from breaking free from the mirror and causing harm.

Product features

- Safety glass.
- Simple installation.
- Screws included.

Dimensions	200 x 1250 x 2.5 cm 200 x 100 x 2.5 cm 170 x 100 x 2.5 cm
Frame colour	Silver or black
Mirror thickness	4 mm
Total weight	200 cm height: 30 kg 170 cm height: 25 kg 120 cm height: 15 kg



BORIS



A wall mounted mirror with a 10 x 5 cm screen printed grid pattern on its surface. Suitable for rehabilitation and posture correction centres. Hung flat against the wall and designed with safety in mind.

BORIS does not require skilled tradesmen to install. It has an aluminium frame available in silver or black and can be mounted vertically or horizontally.

There is a security film applied in its construction to make the mirror safe in case of accidental damage. The film serves to prevent broken glass shards from breaking free from the mirror and causing harm.

Product features

- Safety glass.
- 10 x 5 cm grid pattern on surface.
- Simple installation.
- Screws included.

Dimensions	200 x 100 x 2.5 cm 170 x 100 x 2.5 cm 120 x 80 x 2.5 cm
Frame colour	Silver or black
Mirror thickness	4 mm
Total weight	200 cm height: 30 kg 170 cm height: 25 kg 120 cm height: 15 kg
Screen printed	10 x 5 cm grid pattern



ARABESQUE DOUBLE support and bars not included.

A wall mounted mirror with a central 10 x 20 cm opening that allows the attachment of our ARABESQUE-SINGLE or DOUBLE wall brackets to give a complete mirror and barre installation. Hung flat against the wall and designed with safety in mind.

AMADEUS does not require skilled tradesmen to install. It has an aluminium frame available in silver or black.

There is a security film applied in its construction to make the mirror safe in case of accidental damage. The film serves to prevent broken glass shards from breaking free from the mirror and causing harm.

Product features

- Safety glass.
- Option of 10 x 5 cm grid pattern on surface.
- Simple installation.
- Screws included.

Dimensions	200 x 100 x 2.5 cm 170 x 100 x 2.5 cm
Frame colour	Silver or black
Dimensions of opening	10 x 20 cm
Position of opening	refer to technical drawing
Mirror thickness	4 mm
Total weight	200 cm height: 30 kg 170 cm height: 25 kg
Screen printed (option)	10 x 5 cm grid pattern

Ex: AMADEUS mirror (200x100) + ARABESQUE DOUBLE support

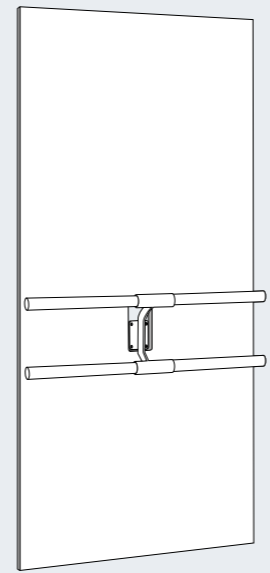
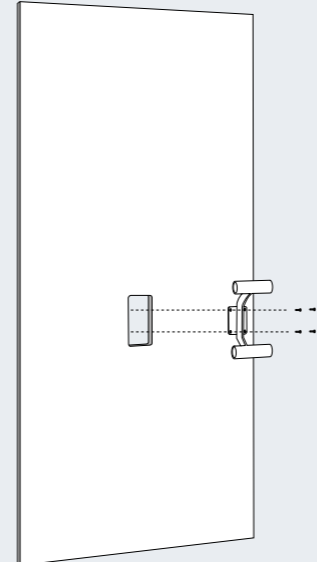
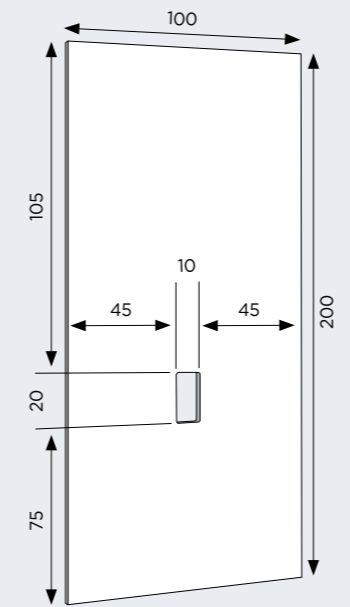

MIRRORS + SINGLE WALL MOUNTED SUPPORTS



MIRROR SET 3 m ARABESQUE SINGLE

Dimensions: 200 x 300 cm

Content:

- 1 FIGARO 200 x 100 cm
- 2 AMADEUS 200 x 100 cm
- 2 ARABESQUE Single
- 1 wooden beam 3 m

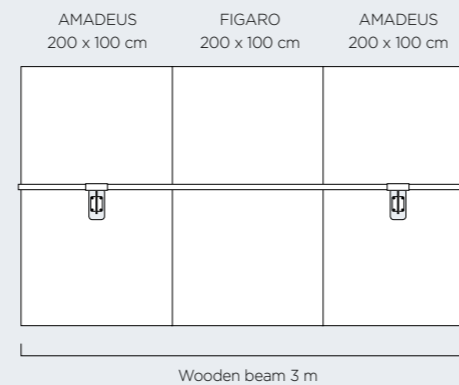

Single steel wall brackets in silver or black.



MIRROR SET 4 m ARABESQUE SINGLE

Dimensions: 200 x 400 cm

Content:

- 4 AMADEUS 200 x 100 cm
- 4 ARABESQUE Single
- 1 wooden beam 1 m
- 2 wooden beam 1,5 m

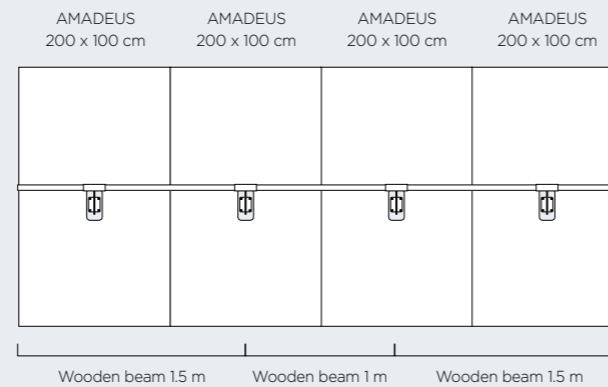

Single steel wall brackets in silver or black.



MIRROR SET 5 m ARABESQUE SINGLE

Dimensions: 200 x 500 cm

Content:

- 2 FIGARO 200 x 100 cm
- 3 AMADEUS 200 x 100 cm
- 3 ARABESQUE Single
- 2 wooden beam 2,5 m

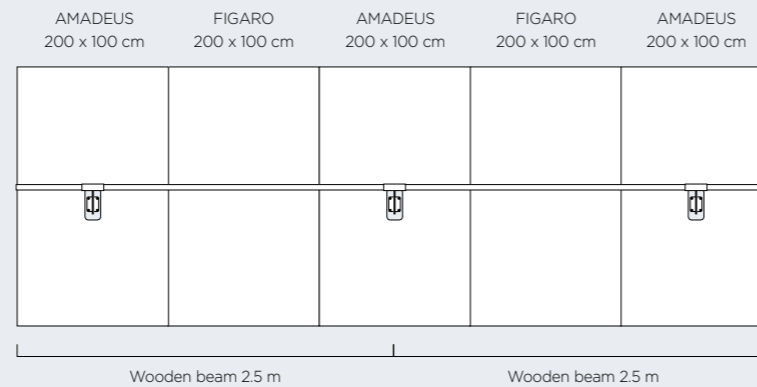

Single steel wall brackets in silver or black.



MIRROR SET 6 m ARABESQUE SINGLE

Dimensions: 200 x 600 cm

Content:

- 2 FIGARO 200 x 100 cm
- 4 AMADEUS 200 x 100 cm
- 4 ARABESQUE Single
- 1 wooden beam 1 m
- 2 wooden beam 2,5 m

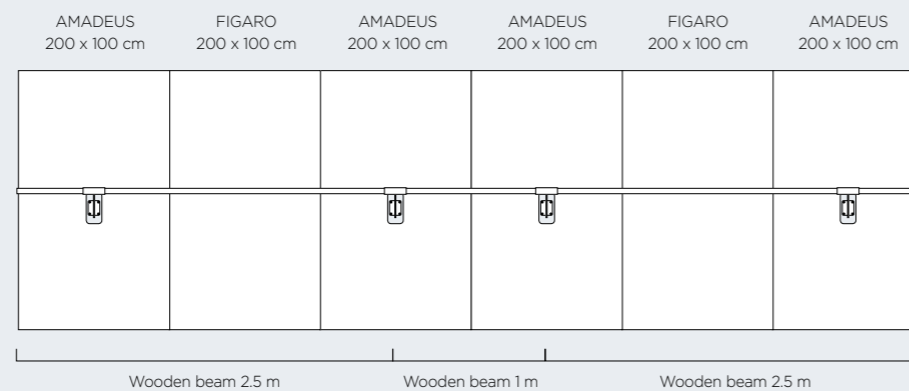

Single steel wall brackets in silver or black.



MIRRORS + DOUBLE WALL MOUNTED SUPPORTS



MIRROR SET 3 m ARABESQUE DOUBLE

Dimensions: 200 x 300 cm

Content:

- 1 FIGARO 200 x 100 cm
- 2 AMADEUS 200 x 100 cm
- 2 ARABESQUE Double
- 2 wooden beam 3 m

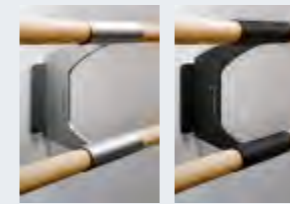
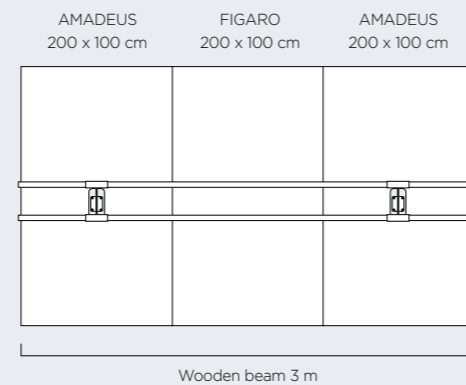

Double steel wall brackets in silver or black.



MIRROR SET 4 m ARABESQUE DOUBLE

Dimensions: 200 x 400 cm

Content:

- 4 AMADEUS 200 x 100 cm
- 4 ARABESQUE Double
- 2 wooden beam 1 m
- 4 wooden beam 1,5 m

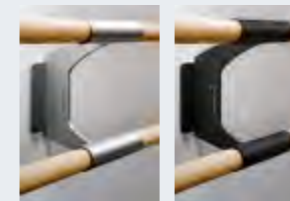
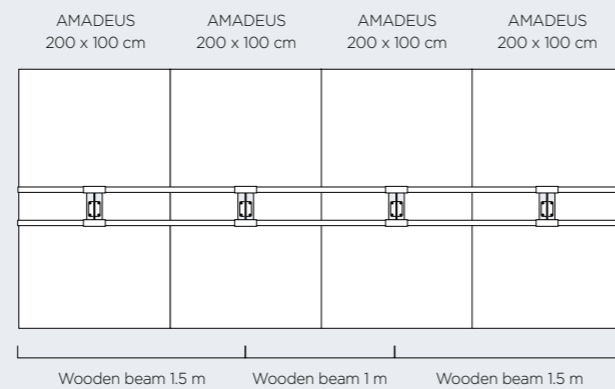

Double steel wall brackets in silver or black.

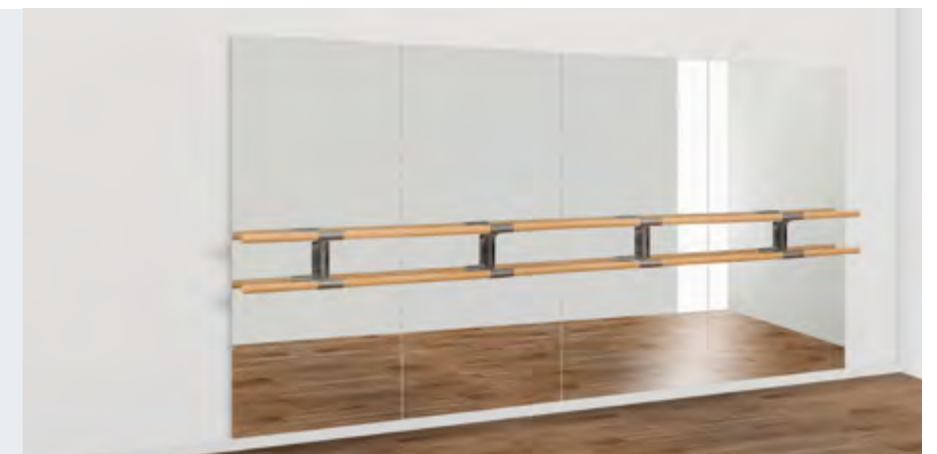

MIRROR SET 5 m ARABESQUE DOUBLE

Dimensions: 200 x 500 cm

Content:

- 2 FIGARO 200 x 100 cm
- 3 AMADEUS 200 x 100 cm
- 3 ARABESQUE Double
- 4 wooden beam 2,5 m

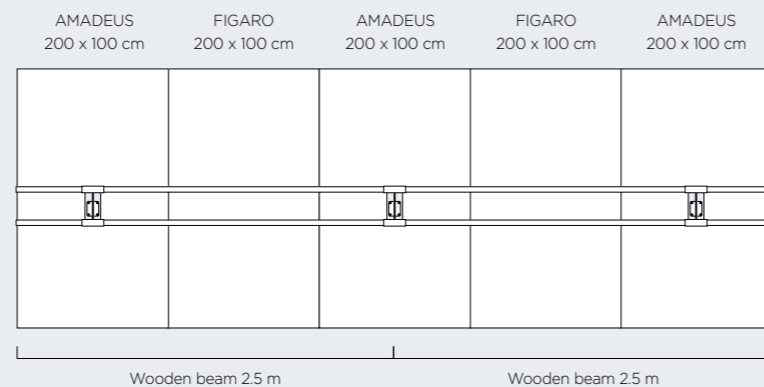

Double steel wall brackets in silver or black.



MIRROR SET 6 m ARABESQUE DOUBLE

Dimensions: 200 x 600 cm

Content:

- 2 FIGARO 200 x 100 cm
- 4 AMADEUS 200 x 100 cm
- 4 ARABESQUE Double
- 2 wooden beam 1 m
- 4 wooden beam 2,5 m

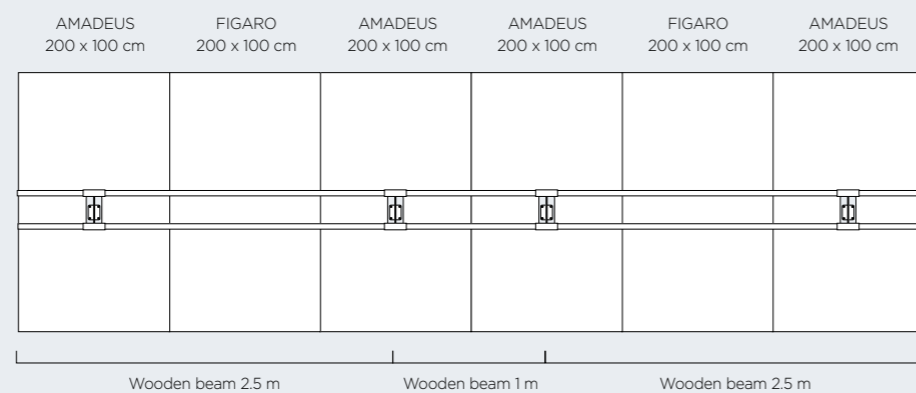

Double steel wall brackets in silver or black.





ONDINE

REVERSIBLE DANCE MAT

The dance mat Ondine offers you the perfect cushioning and stability for your exercises. It's a reversible performance mat made with two layers of soft, non-slip PVC to give you complete confidence in your turns. The mat is available in three sizes, so you can train at home or take it with you to rehearsals or on tour. Whether yours is classical dance or hip hop, modern or jazz, or even percussion dances such as flamenco or tap, the mat will quickly become a fixture in your rehearsals.



THREE AVAILABLE SIZES

The Ondine mat is available in three sizes so you can work with ballet barres of different measurements:

- 200 x 100 cm
- 200 x 150 cm
- 200 x 195 cm



Reversible: black / light grey

TWO MATS IN ONE FOR DEMANDING DANCERS

This is a reversible performance mat, grey on one side and black on the other, so you can choose which suits your taste or surroundings. Unroll the mat and use it equally on both sides to minimize wear and tear, and to change its look to go with your space.

The mat has a soft feel and offers the perfect cushioning and grip for any type of exercises in any dance discipline with or without the use of a ballet barre. The two non-slip PVC layers stay put on any type of floor surface, and if you want extra security to ensure it won't budge from place, you can also add adhesive tape.





dinamica ballet

DINÀMICA COMPLEMENTS, S.L.

Llull, 51-53, 5º 3ª | 08005 BARCELONA (SPAIN)

Tel. +34 93 486 31 35

export@dinamicaballet.com

www.dinamicaballet.com

